



Cross Roller Bearing



Cross Roller Bearing

Construction

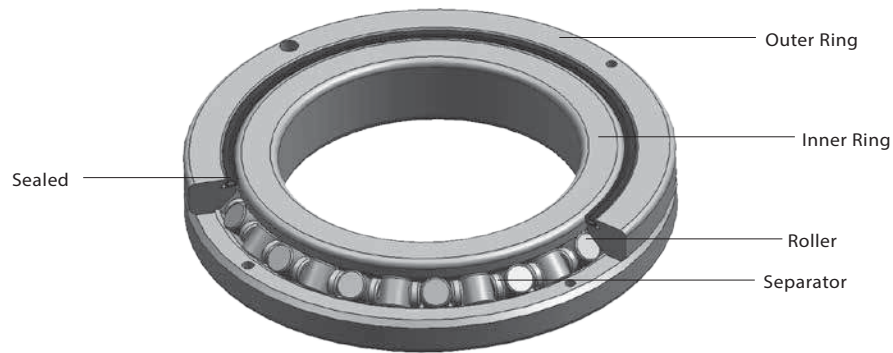

Characteristics

To solve the problem of reducing the mechanism which use one bearing to replace two bearing solution. PMI's designs and manufactures a variety of cross roller bearings that can handle radial, thrust and moment loads at the same time. These compact bearing feature rollers crossed at right angles between inner and outer rings. This structure can reduce the combined height required for bearings, achieving high rigidity and excellent load capacity. There are currently standard type CRB, mounting holed type CRBF, robots installation type CRBR and customization type CRBX for choose.

Application

It suitable used in the rotating parts of machine tools, industrial robots, measuring instrument and IC manufacturing.

Features

High Accuracy

PMI offers precision cross roller bearing in the P2, P4, P5, P6 and P0 grades that to satisfy the needs of customers for precision equipment. The bearings produced by the test are classified that according to the accuracy of the ISO standard.

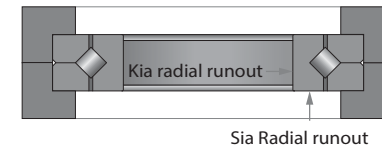

High Rigidity \ High Load Capacity

Rollers crossed at right angles between inner and outer rings, the roller and groove contact area compare with ball bearings is bigger and contributing to miniaturization and increase load capacity and rigidity.

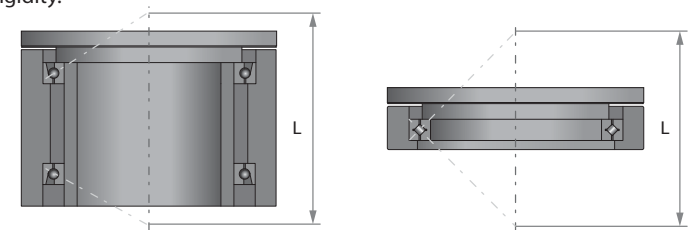

Save Space

Traditional ball bearing combination space larger than cross roller bearing about 1.5~2 times, reduce the design space and miniaturization.

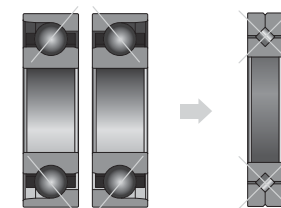

Traditional Ball bearing Cross Roller Bearing

Specification Diversification

Bore diameter 20mm to 160mm available for selection.

Crowning Rollers

The rollers designed crowning curve that to avoid stress concentrate at both ends of the roller for the reason that it is maximum stress value of the roller can be reduced and the loading is relatively average, so improve the life of cross roller bearing.

Category

Standard Type - CRBC/CRBB/CRBH

According to the application choosing the type that outer ring or inner separation structure suit for high rotation accuracy. For example: the rotating part of the rotating platform.

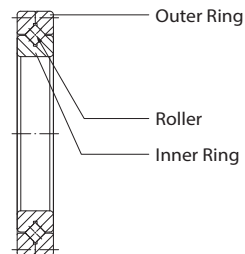

Mounting Holed Type - CRBF/CRBE

Mounting holes for direct fixing on outer and inner ring, helps produce smaller and lightweight equipment, product design becomes more compact, CRBF can be assembled on the device according to the customers use, reduce the costs and delivery.

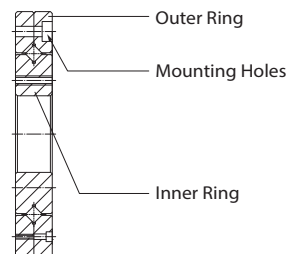
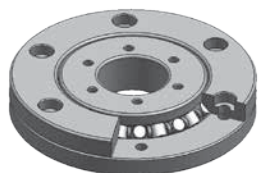

Robots Installation Type - CRBR

Robots Installation type CRBR the outer ring is made of two split pieces, inner ring as a whole structure, mounting holes for direct fixing on mating mounting surface are available, east installation, suitable for harmonic drive CSG(CSF) series and Multi-axis robot.

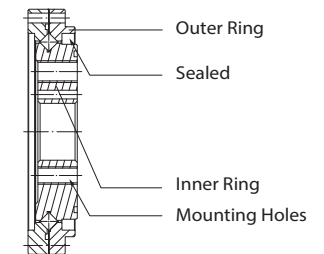

Hollow Rotary Type - CRBG

Hollow rotary type cross roller bearing, design of the mounting hole makes it easier to install, simplifies the structure of rotating application, it is suitable for rotating positions requiring high precision and compact structure, such as the machining 4th axis and robotic arm joints.

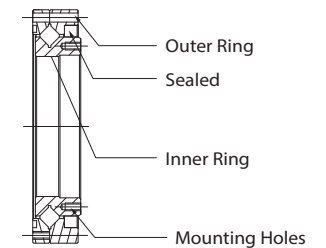

Customization Type - CRBX

The space required for the paired combination of angular bearings is about 1.5~2 times that of cross roller bearings, so the design space and volume can bereduced.



Specification

Standard Type - CRBC/CRBB/CRBH

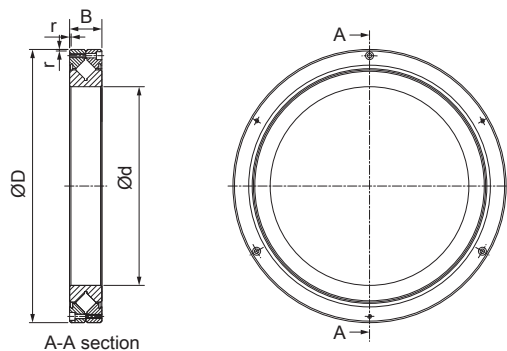

Unit : mm

CRBC/CRBB/CRBH	D	d	B	r _{min}
3010	55	30	10	0.5
4010	65	40	10	0.6
4510	70	45	10	0.6
5013	80	50	13	0.7
6013	90	60	13	0.7
7013	100	70	13	0.7
8013	110	80	13	0.8
8016	120	80	16	0.8
9016	130	90	16	0.8
10020	150	100	20	1.0
11020	160	110	20	1.0
12025	180	120	25	1.8
13025	190	130	25	1.5
14016	175	140	16	1.5
14025	200	140	25	1.8
15013	180	150	13	1.8
15025	210	150	25	1.8
15030	230	150	30	2
16025	220	160	25	2

Note*: If you need any others size or specification, please do not hesitate to contact **PMI**.

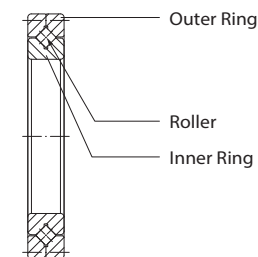

Unit : mm

CRBC/CRBB/CRBH	Mass (kg)	Dynamic load rating C(N)	Static load rating C(N)
3010	0.12	4500	5100
4010	0.15	8000	9300
4510	0.17	8400	10300
5013	0.29	14900	16700
6013	0.33	16300	18900
7013	0.38	17500	21800
8013	0.7	18200	24600
8016	0.74	18700	26100
9016	0.81	21000	28900
10020	1.45	34800	50600
11020	1.56	36400	54900
12025	2.62	40700	56400
13025	2.82	41700	59700
14016	1	38800	63500
14025	2.96	42300	64600
15013	0.68	24800	44700
15025	3.16	47400	67900
15030	5.3	45700	71200
16025	3.14	45700	71200

Mounting Holed Type - CRBF/CRBE

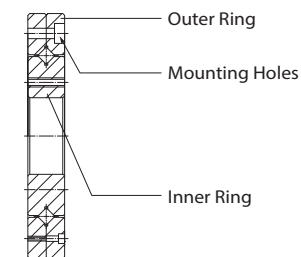
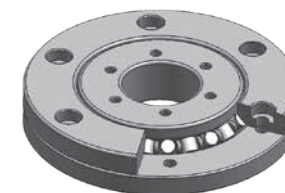
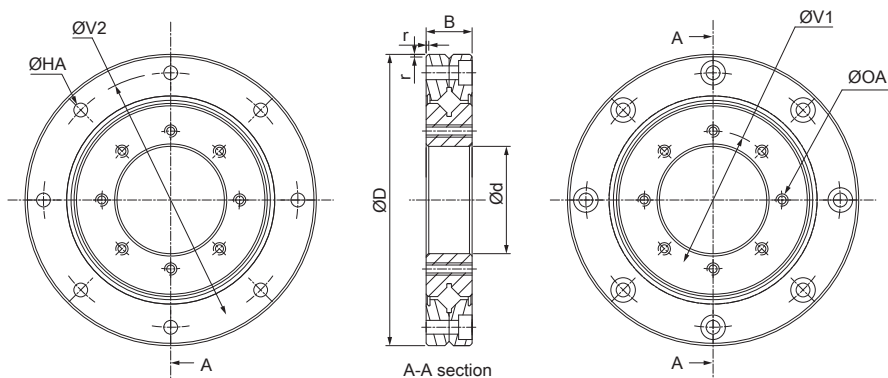

Unit : mm

CRBF/CRBE	Boundary dimensions						
	D	d	B	M	r _{min}	OA	HA
1008	52	10	8	8	0.6	4-M3x0.5P	6-Ø3.4 through Ø6.5 counter bore depth 3.3
2012	70	20	12	12	0.6	6-M3x0.5P	6-Ø3.4 through Ø6.5 counter bore depth 3.3
2512	80	25	12	12	0.7	6-M3x0.5P	6-Ø3.4 through Ø6.5 counter bore depth 3.3
3515	95	35	15	15	0.9	8-M4x0.7P	8-Ø4.5 through Ø8 counter bore depth 4.4
5515	120	55	15	15	0.9	8-M5x0.8P	8-Ø5.5 through Ø9.5 counter bore depth 5.4
8022	165	80	22	22	1.4	10-M5x0.8P	10-Ø5.5 through Ø9.5 counter bore depth 5.4
9025	210	90	25	25	1.8	12-M8x1.25P	12-Ø9 through Ø14 counter bore depth 11

Unit : mm

CRBF/CRBE	Boundary dimensions		Mass (Kg)	Dynamic load rating C(N)	Static load rating C(N)
	V1 (PCD)	V2 (PCD)			
1008	16	42	0.12	3400	3000
2012	28	57	0.31	7000	7400
2512	35	67	0.4	8000	9300
3515	45	83	0.66	14900	16700
5515	65	105	0.96	17400	22500
8022	97	148	2.6	34100	49000
9025	112	187	4.67	40700	56400

Note*: If you need any others size or specification, please do not hesitate to contact **PMI**.

Robots Installation Type - CRBR

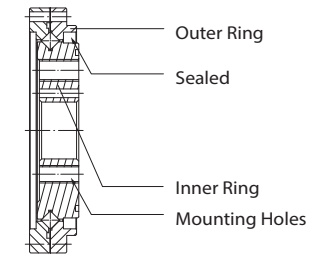
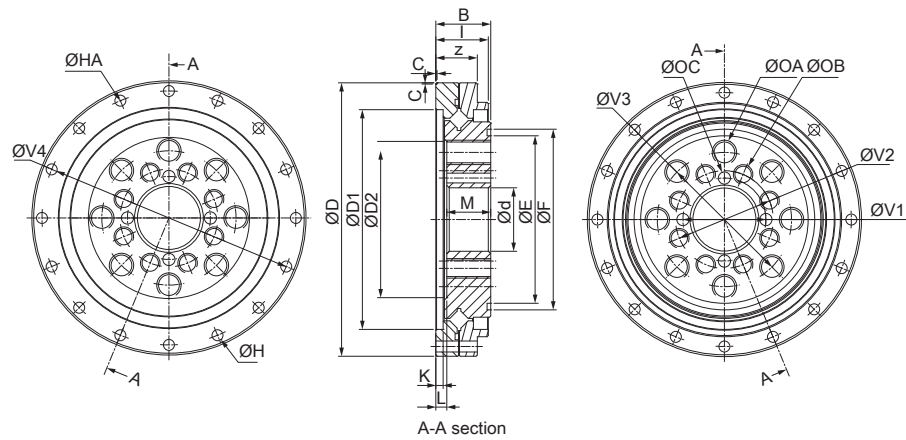

Unit : mm

CRBR	Boundary dimensions														
	D	tolerance	d	D1	tolerance	D2	E	F	M	z	I	B	K	L	C
14	55	$\frac{0}{-0.03}$	11	41.8	$\frac{+0.02}{0}$	28	28.4	29.8	13.5	12	16	16.5	2.5	4	0.3
17	62	$\frac{0}{-0.03}$	10	49	$\frac{+0.02}{0}$	34	33.8	36	13.5	12	16	16.5	2.5	4	0.5
20	70	$\frac{0}{-0.03}$	14	56.5	$\frac{+0.02}{0}$	40	40.2	43	13.5	12.5	16	16.5	2.5	4.5	0.7
25	85	$\frac{0}{-0.03}$	20	67	$\frac{+0.02}{0}$	50	52.6	55.3	15	14	18	18.5	2	3.5	1
32	112	$\frac{0}{-0.03}$	26	90	$\frac{+0.03}{0}$	64	68.6	74	18	17	21.6	22.5	3	4.5	1.2
40	126	$\frac{0}{-0.035}$	24-32	105	$\frac{+0.03}{0}$	79	81.2	86	21.5	16.5	22.5	24	2.5	4.5	1.5

Unit : mm

CRBR	Boundary dimensions								Mass (Kg)	Dynamic load rating C(N)	Static load rating C(N)	
	OA	OB	OC	HA	V1	V2	V3	V4				
14	6-M4x0.7P	6-M4x0.7P	3- $\varnothing 3$	± 0.01	8-3.5	15	17	23	49	0.1	4100	4200
17	6-M5x0.8P	6-M5x0.8P	3- $\varnothing 3$	± 0.01	10-3.5	15	19	27	56	0.15	4400	4900
20	8-M6x1P	8-M5x0.8P	4- $\varnothing 3$	$\frac{+0.02}{0}$	12-3.5	19	24	32	64	0.24	5000	6200
25	8-M8x1.25P	8-M6x1P	4- $\varnothing 3$	$\frac{+0.02}{0}$	16-3.5	26	30	42	79	0.5	8800	11300
32	8-M10x1.5P	8-M8x1.25P	4- $\varnothing 5$	± 0.03	16-4.5	34	40	55	104	1.24	17100	21800
40	8-M10x1.5P	8-M10x1.5P	4- $\varnothing 5$	± 0.03	20-4.0	42	50	68	117	1.7	19000	26800

Note*: If you need any others size or specification, please do not hesitate to contact **PMI**.

Hollow Rotary Type - CRBG

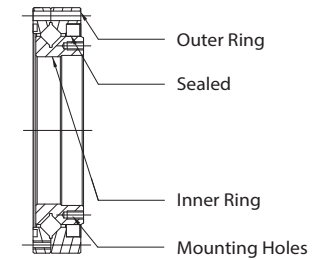
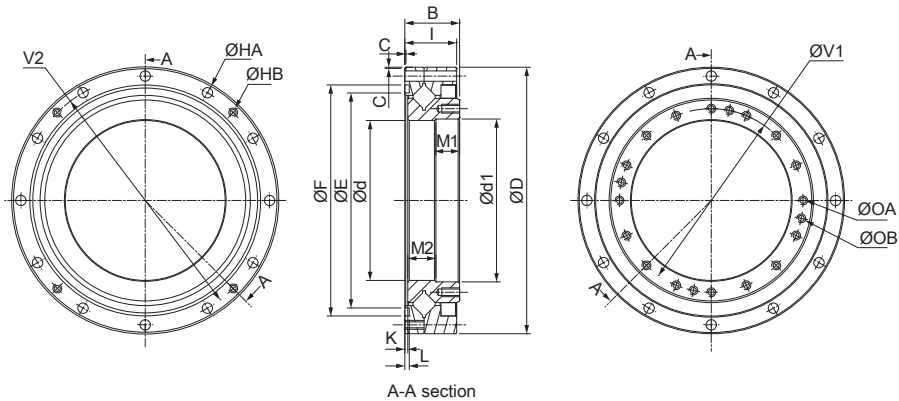

Unit : mm

CRBG	Boundary dimensions												
	D	tolerance	d	d1	E	F	M1	M2	I	B	K	L	C
14	70	$\frac{0}{-0.013}$	36±0.05	Ø38	53	57	5	9.6	14.1	15.1±0.05	0.5	1.1	0.5
17	80	$\frac{0}{-0.013}$	45.5±0.05	Ø47	63	68	6.5	9.9	16	17±0.05	0.6	1.1	0.5
20	90	$\frac{0}{-0.015}$	54±0.05	Ø55	72.6	78	8	9.5	17.5	18.5±0.05	1	1.5	0.5
25	110	$\frac{0}{-0.015}$	66±0.05	Ø67	90	94.8	7.5	12.2	18.7	20.7±0.05	1	1.5	1
32	142	$\frac{0}{-0.018}$	84±0.05	Ø88	117.6	123	8	15.4	23.4	24.4±0.05	1	1.5	1.2
40	170	$\frac{0}{-0.02}$	106±0.05	Ø108	142.6	148	9.5	19	29	30±0.05	1.5	1.5	1.5
45	190	$\frac{0}{-0.02}$	118±0.05	Ø120	164	170	9.5	22	32	33±0.05	1.5		2

Unit : mm

CRBG	Boundary dimensions						Mass (Kg)	Dynamic load rating C(N)	Static load rating C(N)
	OA	OB	HA	HB	V1	V2			
14	12-M3x0.5Px6L	-	8-Ø3.5	2-M3x0.5Px7L	44	64	0.25	7800	9000
17	20-M3x0.5Px6L	-	12-Ø3.5	4-M3x0.5Px10L	54	74	0.34	8700	11000
20	16-M3x0.5Px6L	4-M3x0.5Px6L	12-Ø3.5	4-M3x0.5Px6.5L	62	84	0.44	15600	18200
25	16-M4x0.7Px8L	4-M3x0.5Px6L	12-Ø4.5	4-M3x0.5Px7.5L	77	102	0.73	17400	22500
32	16-M5x0.8Px8L	4-M4x0.7Px8L	12-Ø5.5	4-M4x0.7Px9L	100	132	1.49	33200	46300
40	16-M6x1Px10L	4-M5x0.8Px10L	12-Ø6.6	4-M4x0.7Px11L	122	158	2.62	36200	54900
45	12-M8x1.25Px10L	4-M5x0.8Px10L	12-Ø6.6	4-M4x0.7Px14L	140	180	3.65	39100	63500

Note*: If you need any others size or specification, please do not hesitate to contact **PMI**.

Specification accuracy of product dimensional

• CRBC / CRBH / CRBB

CRBC / CRBH / CRBB Inner diameter of bearing allowable tolerance (standard)

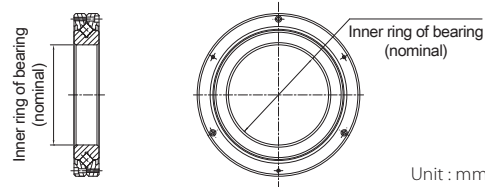

Unit : mm

d		Δ dmp							
Nominal bearing inside diameter (mm)		Tolerance of average inner diameter							
		Class 0		Class 6		Class 5		Class 4 \ 2	
above	below(Incl.)	High	Low	High	Low	High	Low	High	Low
18~30		-10	0	-8	0	-6	0	-5	
30~50		-12	0	-10	0	-8	0	-6	
50~80		-15	0	-12	0	-9	0	-7	
80~120		-20	0	-15	0	-10	0	-8	
120~150		-25	0	-18	0	-13	0	-10	
150~180		-25	0	-18	0	-13	0	-10	
180~250		-30	0	-22	0	-15	0	-12	
250~315		-35	0	-25	0	-18	-	-	
315~400		-40	0	-30	0	-23	-	-	
400~500		-45	0	-35	-	-	-	-	
500~630		-50	0	-40	-	-	-	-	
630~800		-75	-	-	-	-	-	-	

The width of bearing outer ring

The width of bearing inner ring



Unit : mm

CRBC / CRBH / CRBB The width of bearing allowable tolerance(standard type)

d		Δ Bs		Δ Cs	
Nominal bearing inside diameter (mm)		Width of inner ring dimension tolerance		Width of outer ring dimension tolerance	
above	below(Incl.)	High	Low	High	Low
18~30		0	-75	0	-100
30~50		0	-75	0	-100
50~80		0	-75	0	-100
80~120		0	-75	0	-100
120~150		0	-100	0	-120
150~180		0	-100	0	-120
180~250		0	-100	0	-120
250~315		0	-120	0	-150
315~400		0	-150	0	-200
400~500		0	-150	0	-200
500~630		0	-150	0	-200
630~800		0	-150	0	-200

CRBC / CRBH / CRBB Outer diameter of bearing allowable tolerance (standard)

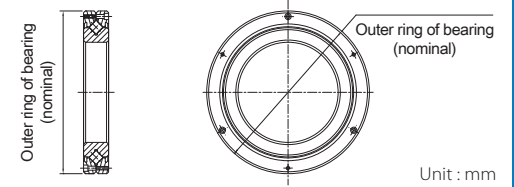

Unit : mm

d		Δ dmp							
Nominal bearing outer diameter (mm)		Tolerance of average bearing outer diameter							
		Class 0		Class 6		Class 5		Class 4 \ 2	
above	below(Incl.)	High	Low	High	Low	High	Low	High	Low
18~30		0	-11	0	-9	0	-7	0	-6
30~50		0	-13	0	-11	0	-9	0	-7
50~80		0	-15	0	-13	0	-10	0	-8
80~120		0	-18	0	-15	0	-11	0	-9
120~150		0	-25	0	-18	0	-13	0	-10
150~180		0	-25	0	-20	0	-15	0	-11
180~250		0	-35	0	-25	0	-18	0	-13
250~315		0	-40	0	-28	0	-20	-	-
315~400		0	-45	0	-33	0	-23	-	-
400~500		0	-50	0	-38	0	-28	-	-
500~630		0	-75	0	-45	-	-	-	-
630~800		0	-100	0	-60	-	-	-	-
1000~1030		0	-125	-	-	-	-	-	-

Note*: If the standard type of cross roller bearing (CRBC.CRBH) is P2, please refer to the Class 4. (allowable tolerances of the inner and outer diameter)

• CRBF / CRBE

CRBF / CRBE Inner diameter of bearing allowable tolerance (mounting holed)

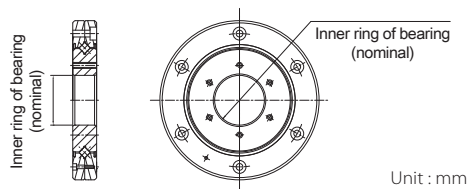

Unit : mm

d		Δ dmp							
Nominal bearing inside diameter		Tolerance of average inner diameter							
(mm)		Class 0		Class 6		Class 5		Class 4 \ 2	
above	below(Incl.)	High	Low	High	Low	High	Low	High	Low
0~20		0	-10	0	-8	0	-6	0	-5
20~30		0	-10	0	-8	0	-6	0	-5
30~35		0	-12	0	-10	0	-8	0	-6
35~50		0	-12	0	-10	0	-8	0	-6
50~65		0	-15	0	-12	0	-9	0	-7
65~80		0	-15	0	-12	0	-9	0	-7
80~100		0	-20	0	-15	0	-10	0	-8
100~120		0	-20	0	-15	0	-10	0	-8

CRBF / CRBE Outer diameter of bearing allowable tolerance (mounting holed)

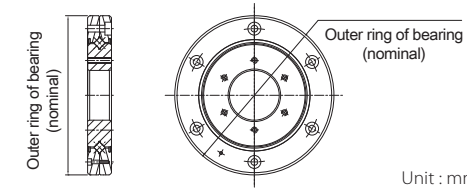

Unit : mm

d		Δ dmp							
Nominal bearing outer diameter		Tolerance of average outer diameter							
(mm)		Class 0		Class 6		Class 5		Class 4 \ 2	
above	below(Incl.)	High	Low	High	Low	High	Low	High	Low
50~60		0	-13	0	-11	0	-9	0	-7
60~80		0	-13	0	-11	0	-9	0	-7
80~95		0	-15	0	-13	0	-10	0	-8
95~120		0	-15	0	-13	0	-10	0	-8
120~140		0	-18	0	-15	0	-11	0	-9
140~150		0	-18	0	-15	0	-11	0	-9
150~165		0	-25	0	-18	0	-13	0	-10
165~180		0	-25	0	-18	0	-13	0	-10
180~210		0	-30	0	-20	0	-15	0	-11
210~240		0	-30	0	-20	0	-15	0	-11

Note*: If the mounting holed type of cross roller bearing (CRBF,CRBE) is P2, please refer to the Class 4. (allowable tolerances of the inner and outer diameter)

CRBF / CRBE Outer diameter of bearing allowable tolerance (mounting holed)

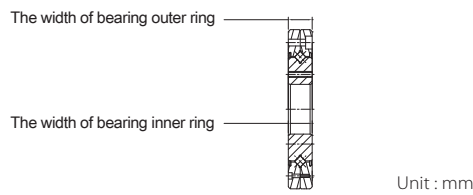

Unit : mm

d		Δ Bs		D		Δ Cs	
Nominal bearing inside diameter		Width of inner ring		Nominal bearing outer diameter		Width of outer ring	
(mm)		dimension tolerance		(mm)		dimension tolerance	
above	below(Incl.)	High	Low	above	below(Incl.)	High	Low
0~20		0	-75	50~60		0	-75
20~30		0	-75	60~80		0	-75
30~35		0	-75	80~95		0	-75
35~50		0	-75	95~120		0	-75
50~65		0	-75	120~140		0	-75
65~80		0	-75	140~150		0	-75
80~100		0	-75	150~165		0	-75
100~120		0	-75	165~180		0	-75
				180~210		0	-75
				210~240		0	-75

Note*: The width of mounting holed cross roller bearing (CRBF,CRBE) don't have class standard.

Specification for dynamic accuracy of product

• CRBC / CRBH / CRBB

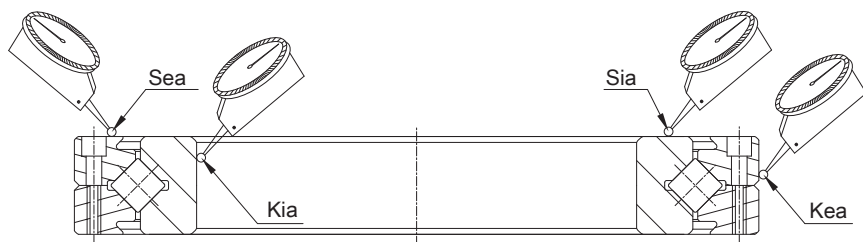

Allowable dynamic accuracy of bearing inner ring

Unit : mm

d Nominal bearing inside diameter (mm)		Kia Radial run-out					Sia Axial run-out				
above	below(Incl.)	Class 0	Class 6	Class 5	Class 4	Class 2	Class 0	Class 6	Class 5	Class 4	Class 2
18~30		13	8	4	3	2.5	13	8	4	3	2.5
30~50		15	10	5	4	2.5	15	10	5	4	2.5
50~80		15	10	5	4	2.5	15	10	5	4	2.5
80~120		20	10	5	4	2.5	20	10	5	4	2.5
120~150		20	10	5	4	2.5	20	10	5	4	2.5
150~180		25	13	6	5	2.5	25	13	6	5	2.5
180~250		25	13	6	5	2.5	25	13	6	5	2.5
250~315		30	18	8	6	2.5	30	18	8	6	2.5
315~400		60	30	15	12	8	60	30	15	12	8
400~500		65	35	18	14	10	65	35	18	14	10
500~630		70	40	20	16	12	70	40	20	16	12
630~800		80	50	25	20	15	80	50	25	20	15

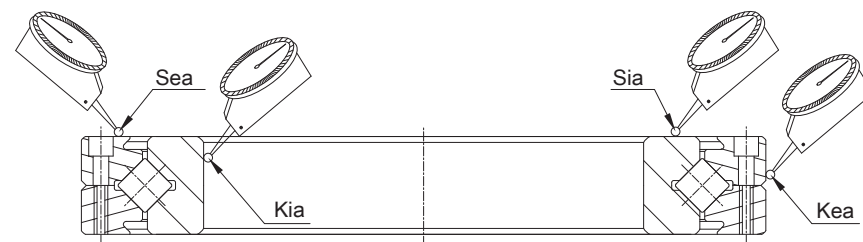

Allowable dynamic accuracy of bearing outer ring

Unit : mm

d Nominal bearing outer diameter (mm)		Kea Radial run-out					Sea Axial run-out				
above	below(Incl.)	Class 0	Class 6	Class 5	Class 4	Class 2	Class 0	Class 6	Class 5	Class 4	Class 2
30~50		20	10	7	5	2.5	20	10	7	5	2.5
50~80		25	13	8	5	4	25	13	8	5	4
80~120		35	18	10	6	5	35	18	10	6	5
120~150		40	20	11	7	5	40	20	11	7	5
150~180		45	23	13	8	5	45	23	13	8	5
180~250		50	25	15	10	7	50	25	15	10	7
250~315		60	30	18	11	7	60	30	18	11	7
315~400		70	35	20	-	-	70	35	20	-	-
400~500		80	40	23	-	-	80	40	23	-	-
500~630		100	50	25	-	-	100	50	25	-	-
630~800		120	60	30	-	-	120	60	30	-	-
800~1000		120	75	35	-	-	120	75	35	-	-
1000~1030		120	75	35	-	-	120	75	35	-	-

※Radial run-out(Kea, Kia), Axial run-out(Sea, Sia): The split part is not guarantee dynamic accuracy.

• CRBF / CRBE

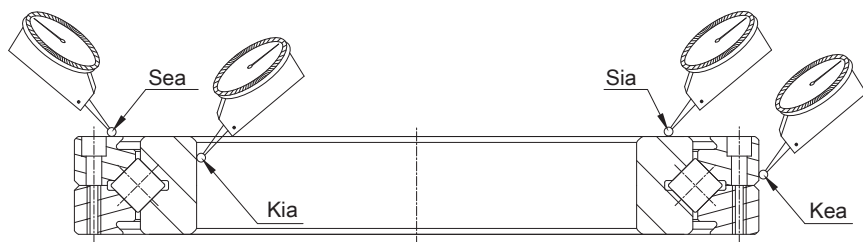

Allowable dynamic accuracy of bearing inner ring

Unit : mm

d		Kia					Sia				
Nominal bearing inside diameter		Radial run-out					Axial run-out				
(mm)											
above	below(Incl.)	Class 0	Class 6	Class 5	Class 4	Class 2	Class 0	Class 6	Class 5	Class 4	Class 2
0~20		13	8	4	3	2.5	13	8	4	3	2.5
20~30		15	10	5	4	2.5	15	10	5	4	2.5
30~35		15	10	5	4	2.5	15	10	5	4	2.5
35~50		20	10	5	4	2.5	20	10	5	4	2.5
50~65		20	10	5	4	2.5	20	10	5	4	2.5
65~80		25	13	6	5	2.5	25	13	6	5	2.5
80~100		25	13	6	5	2.5	25	13	6	5	2.5
100~120			18	8	6	2.5	30	18	8	6	2.5

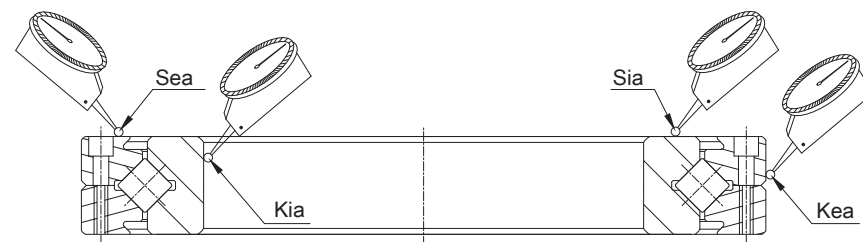

Allowable dynamic accuracy of bearing outer ring

Unit : mm

d		Kea					Sea				
Nominal bearing outer diameter		Radial run-out					Axial run-out				
(mm)											
above	below(Incl.)	Class 0	Class 6	Class 5	Class 4	Class 2	Class 0	Class 6	Class 5	Class 4	Class 2
50~60		20	10	7	5	2.5	20	10	7	5	2.5
60~80		25	13	8	5	4	25	13	8	5	4
80~95		25	13	8	5	4	25	13	8	5	4
95~120		35	18	10	6	5	35	18	10	6	5
120~140		35	18	0	6	5	35	18	10	6	5
140~150		40	20	11	7	5	40	20	11	7	5
150~165		40	20	11	7	5	40	20	11	7	5
165~180		45	23	13	8	5	45	23	13	8	5
180~210		45	23	13	8	5	45	23	13	8	5
210~240		50	25	15	10	7	50	25	15	10	7

※Radial run-out(Kea, Kia), Axial run-out(Sea, Sia): The split part is not guarantee dynamic accuracy.

Specification for internal clearance of product

• CRBC / CRBH / CRBB

CRBC / CRBH / CRBB Inner ring of bearing's radial clearance (standard type)

Unit : mm

d Nominal bearing inside diameter (mm)		Radial clearance of inner diameter					
		T1		C1		C2	
above	below(Incl.)	Min	Max	Max	Min	Max	Min
0~30		-10	0	0	10	10	20
30~40		-10	0	0	10	10	20
40~50		-10	0	0	10	10	25
50~65		-10	0	0	10	10	25
65~80		-10	0	0	15	15	30
80~100		-10	0	0	15	15	35
100~120		-15	0	0	15	15	35
120~140		-15	0	0	20	20	45
140~160		-15	0	0	20	20	50
160~200		-15	0	0	20	20	50
200~250		-20	0	0	25	25	50
250~315		-20	0	0	25	25	60
315~400		-25	0	0	30	30	60
400~500		-30	0	0	40	40	85
500~630		-30	0	0	50	50	100
630~710		-30	0	0	60	60	120
710~800		-30	0	0	70	70	140

• CRBF / CRBE

CRBF / CRBE Inner ring of bearing's radial clearance (mounting holed type)

Unit : mm

d Nominal bearing inside diameter (mm)		Radial clearance of inner diameter					
		T1		C1		C2	
above	below(Incl.)	Min	Max	Max	Min	Max	Min
0~20		-10	0	0	10	10	20
20~25		-10	0	0	10	10	20
25~35		-10	0	0	10	10	25
35~45		-10	0	0	10	10	25
45~65		-10	0	0	15	15	30
65~80		-10	0	0	15	15	35
80~95		-15	0	0	15	15	35
95~110		-15	0	0	20	20	45
110~125		-15	0	0	20	20	50

Description of Specification

CRB C 40 10 A NN T1 P5

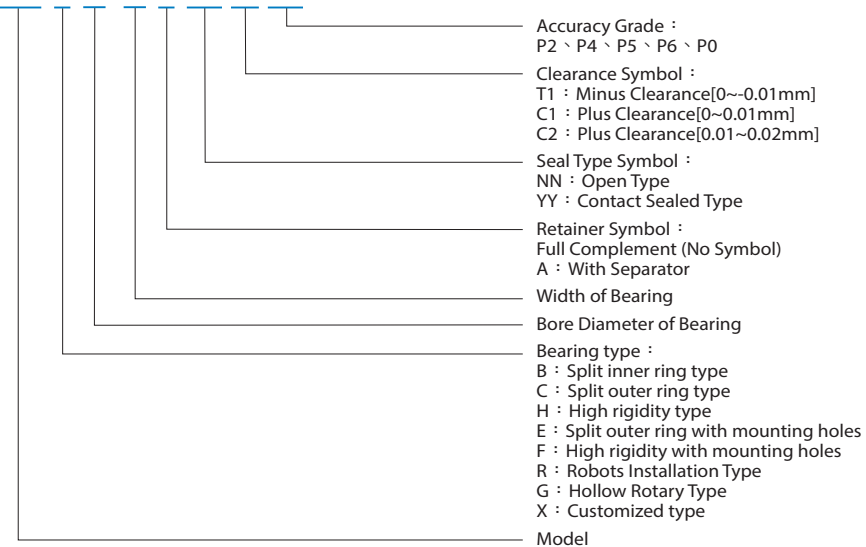

Precautions for use

1. The normal operating temperature of the bearing is 10 - 80 °C. If it exceeds this temperature range, the resin or rubber parts may be deformed and damaged.
2. When foreign matter enters inside of the bearing, it may cause damage to the rolling path of the roller or loss of function. Please pay attention to the cleaning of parts, environment and tools during installation. To prevent foreign matter, dust, etc. from entering the inside of the bearing.
3. If the impact force is applied to the bearing during use, the track surface and the roller will be cracked and indented, resulting in shortened bearing life, so care must be taken.
4. When foreign matter such as chips is found to adhere or invade between the inner and outer rings of the bearing, clean and refill the grease.
5. Please pay attention to the installation, when using the outer ring fixed and inner ring rotation, if need to correct the adjustment, you can only hit the outer ring
6. When installing or removing the bearing, do not apply force to the fixing pin or screw.